

Features

- Low Forward Voltage Drop
- Guard Ring Die Construction for Transient Protection
- Ideal for Low Logic Level Applications
- Low Capacitance
- **Lead Free/RoHS Compliant (Note 3)**
- **"Green" Device (Note 4 and 5)**

Mechanical Data

- Case: SOT-523
- Case Material: Molded Plastic. UL Flammability Classification Rating: 94V-0
- Moisture Sensitivity: Level 1 per J-STD-020C
- Terminals: Solderable per MIL-STD-202, Method 208
- Lead Free Plating (Matte Tin Finish annealed over Alloy 42 leadframe).
- Polarity: See Diagrams Below
- Marking Information: See Diagrams Below & Page 3
- Ordering Information: See Page 3
- Weight: 0.002 grams (approximate)

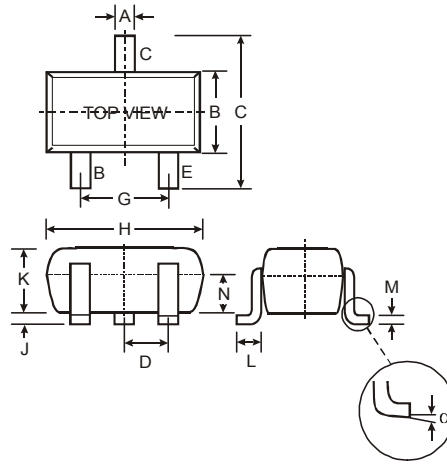

SOT-523			
Dim	Min	Max	Typ
A	0.15	0.30	0.22
B	0.75	0.85	0.80
C	1.45	1.75	1.60
D	—	—	0.50
G	0.90	1.10	1.00
H	1.50	1.70	1.60
J	0.00	0.10	0.05
K	0.60	0.80	0.75
L	0.10	0.30	0.22
M	0.10	0.20	0.12
N	0.45	0.65	0.50
α	0°	8°	—
All Dimensions in mm			

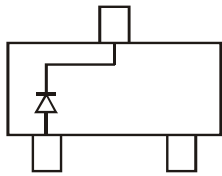

SDMP0340LT Marking: SM

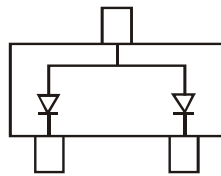

SDMP0340LAT Marking: SQ

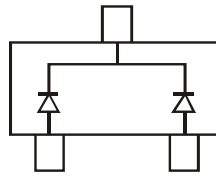

SDMP0340LCT Marking: SP

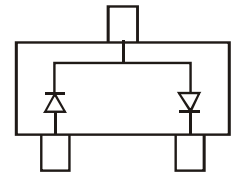

SDMP0340LST Marking: SN

Maximum Ratings @T_A = 25°C unless otherwise specified

Characteristic	Symbol	Value	Unit
Peak Repetitive Reverse Voltage	V _{RRM}	40	V
Working Peak Reverse Voltage	V _{RWM}		
DC Blocking Voltage	V _R		
RMS Reverse Voltage	V _{R(RMS)}	28	V
Forward Continuous Current (Note 1)	I _{FM}	30	mA
Non-Repetitive Peak Forward Surge Current @8.3ms Single half sine-wave superimposed on rated load	I _{FSM}	200	mA
Power Dissipation (Note 1)	P _d	150	mW
Thermal Resistance, Junction to Ambient (Note 1)	R _{θJA}	833	°C/W
Operating and Storage Temperature Range	T _J , T _{STG}	-40 to +125	°C

Electrical Characteristics @T_A = 25°C unless otherwise specified

Characteristic	Symbol	Min	Typ	Max	Unit	Test Condition
Reverse Breakdown Voltage (Note 2)	V _{(BR)R}	40	—	—	V	I _R = 10μA
Forward Voltage Drop	V _F	—	290	370	mV	I _F = 1mA
Leakage Current (Note 2)	I _R	—	—	1.0	μA	V _R = 10V
Total Capacitance	C _T	—	2	—	pF	V _R = 1V, f = 1.0 MHz

- Notes:
1. Device mounted on FR-4 PC board with recommended pad layout, which can be found on our website at <http://www.diodes.com/datasheets/ap02001.pdf>.
 2. Short duration pulse test used to minimize self-heating effect.
 3. No purposefully added lead.
 4. Diodes Inc.'s "Green" policy can be found on our website at http://www.diodes.com/products/lead_free/index.php.
 5. Product manufactured with Date Code UO (week 40, 2007) and newer are built with Green Molding Compound. Product manufactured prior to Date Code UO are built with Non-Green Molding Compound and may contain Halogens or Sb2O3 Fire Retardants.

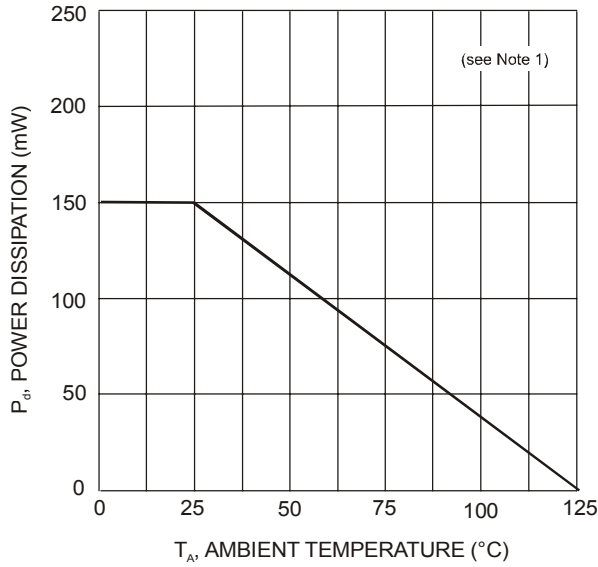

Fig. 1 Power Derating Curve

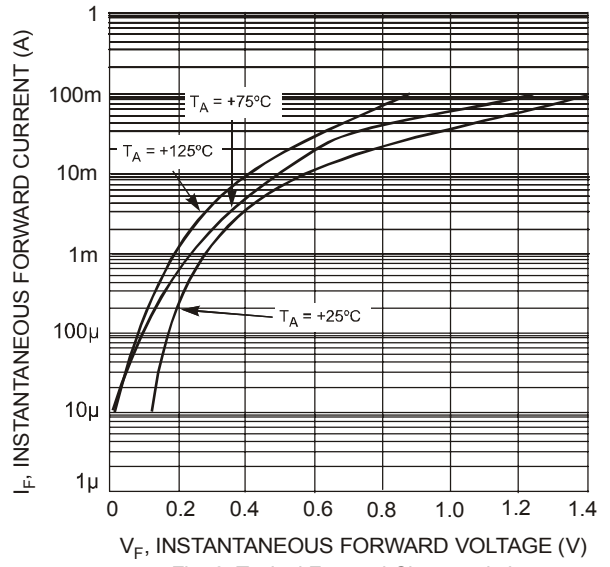

Fig. 2 Typical Forward Characteristics

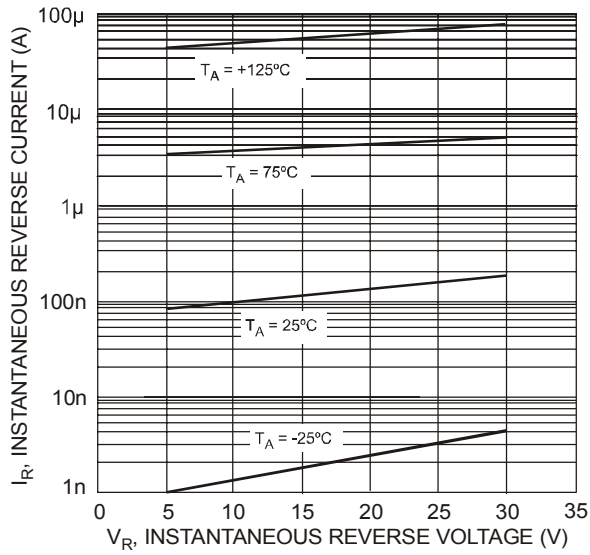

Fig. 3 Typical Reverse Characteristics

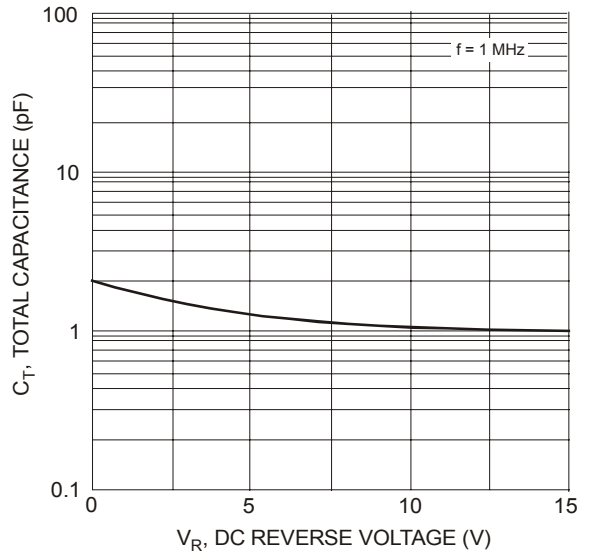

Fig. 4 Typical Capacitance vs. Reverse Voltage

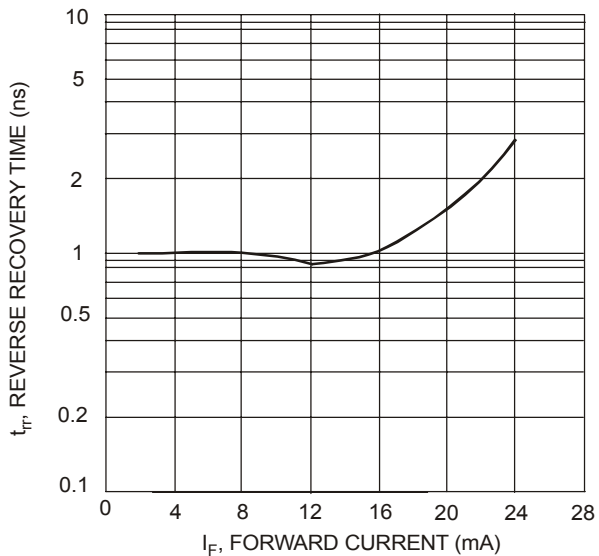

Fig. 5 Typical Reverse Recovery Time Characteristics

Ordering Information (Note 6)

Device	Packaging	Shipping
SDMP0340LT-7-F	SOT-523	3000/Tape & Reel
SDMP0340LST-7-F	SOT-523	3000/Tape & Reel
SDMP0340LCT-7-F	SOT-523	3000/Tape & Reel
SDMP0340LAT-7-F	SOT-523	3000/Tape & Reel

Notes: 6. For packaging details: go to our website at <http://www.diodes.com/datasheets/ap02007.pdf>.

Marking Information

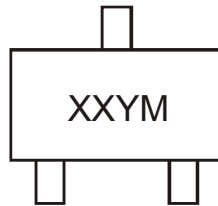

XX = Product Type Marking Code (See Page 1)
 YM = Date Code Marking
 Y = Year (ex: N = 2002)
 M = Month (ex: 9 = September)

Date Code Key

Year	2001	2002	2003	2004	2005	2006	2007	2008	2009	2010	2011	2012
Code	M	N	P	R	S	T	U	V	W	X	Y	Z

Month	Jan	Feb	March	Apr	May	Jun	Jul	Aug	Sep	Oct	Nov	Dec
Code	1	2	3	4	5	6	7	8	9	O	N	D

IMPORTANT NOTICE

Diodes Incorporated and its subsidiaries reserve the right to make modifications, enhancements, improvements, corrections or other changes without further notice to any product herein. Diodes Incorporated does not assume any liability arising out of the application or use of any product described herein; neither does it convey any license under its patent rights, nor the rights of others. The user of products in such applications shall assume all risks of such use and will agree to hold Diodes Incorporated and all the companies whose products are represented on our website, harmless against all damages.

LIFE SUPPORT

Diodes Incorporated products are not authorized for use as critical components in life support devices or systems without the expressed written approval of the President of Diodes Incorporated.